

It's all about the lifestyle



The Avan logo consists of the word 'Avan' in a bold, black, script font. Above the 'A' is a red semi-circle. The entire logo is set against a grey, curved background element.

The Avan Camper Range

www.avan.com.au





The Avan camper ranger whether you are travelling around the state or around the country, your avan camper ensures an enjoyable experience and luxurious living accommodation.

Whether it be a weekend getaway or an extended adventure, the Avan camper range has a model to suit every recreational need. The unique smart design allows simple set-up and pack down giving you more time to enjoy your new surroundings. The entire Avan camper range is compact, light weight, easy to tow and great on fuel economy.



The original Avan camper has long been Australia's most popular 'no canvas' camper.

Thanks to unique engineering design, the Avan camper has 100% solid wall construction and can be assembled in under 30 seconds! The super-strength smooth panel construction, insulated interior and tinted windows provide greater comfort and security than any other folding camper. Giving you peace of mind. Built on Avan's durable Centurion Chassis, all Avan's camper models are versatile enough to take you around the country or just out of town. Clever interior designs can accommodate a family in comfort, while our standard features include 90 Litre fridge, cook-top, deep bowl sink, high-tech construction furniture and ample storage for your holiday essentials.

www.avan.com.au

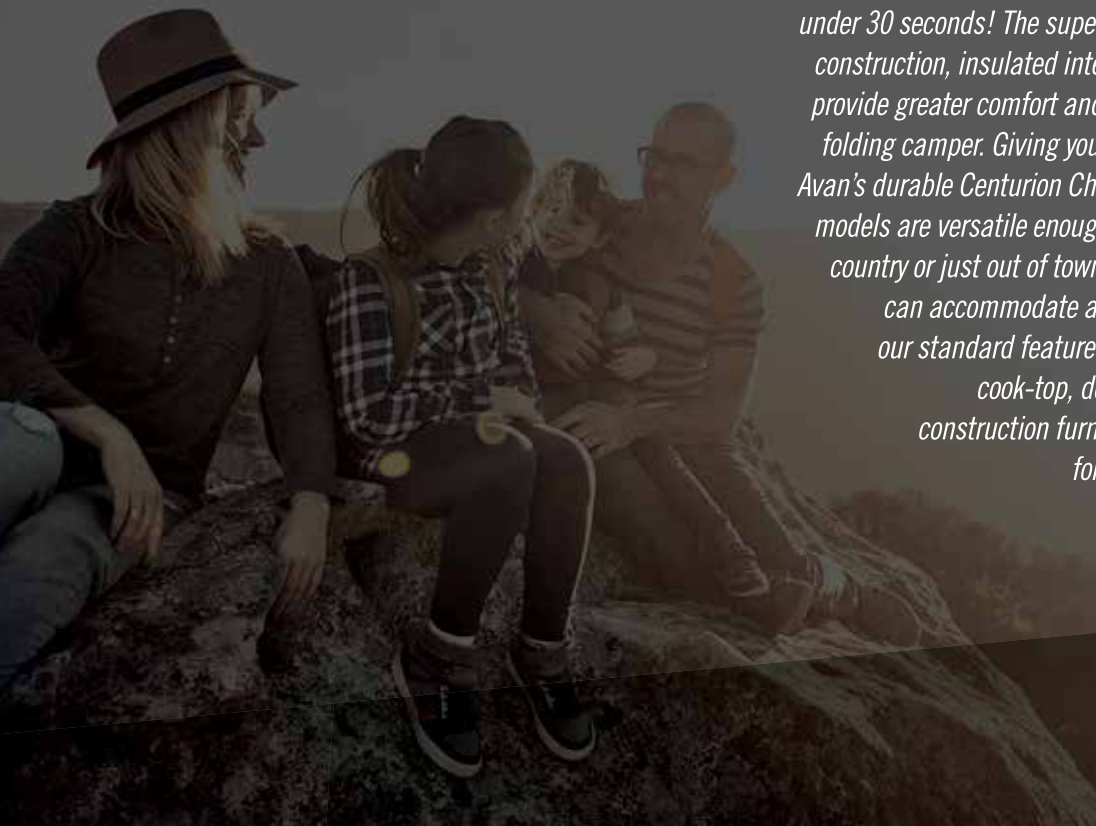

It's all about the lifestyle



External Features

1. Super-strength smooth panel construction
2. Effortless spring-assisted setup
3. Low profile for easy towing
4. Two-piece arched entry door
5. One-piece flooring (no butt-joins)
6. 2 x 4kg gas bottles and regulator
7. Rear bumper mounted spare wheel
8. Lockable mains water connection
9. 60 Ltr water storage tank
10. 100mm storage bumper
11. Swing-up jockey wheel
12. Electric brakes
13. Independent suspension and shocks
14. 240 volt external power point
15. External baggage door
16. Patio light
17. Large front storage boot (Cruiseline only)
18. Hot-dipped galvanized Chassis
19. Drop down corner stabilisers

*Layouts & features are subject to change without notice.
Please check with your dealer prior to purchase.*



Internal Features

1. Fully insulated for all season comfort
2. 2 burner cook top
3. 90lt 3way fridge
4. LED interior lighting
5. Tinted windows and curtains
6. 12v water pump
7. Electric Hot water service
8. Step light
9. USB charging points
10. Auxiliary battery pack with charger

Optional Upgrades

- > Allure Pack interior colour scheme
- > Alternative fixed & wind-out dome configurations
- > Air-conditioner
- > Annexe
- > Microwave oven
- > External shower
- > Radio/CD with fitted speakers
- > Solar panel 20watt or 50watt
- > LED reading lights
- > Additional baggage door

*Layouts & features are subject to change without notice. Please check with your dealer prior to purchase.



The Adventure Pack boasts a host of additional features specifically designed for the more serious camper.

Adventure Pack Upgrades

- > 15" alloys
- > Chassis suspension upgrade or additional road clearance
- > Scratch-resistant paintwork
- > Extra-large jockey wheel

* Allow approximately 30kg extra for Adventure Pack option



It's all about the lifestyle

Adventure Plus Upgrades

The adventure plus range is designed to offer the popular Avan camper layouts with more rugged features and greater ground clearance to suite the outdoor adventuring enthusiast. Now available as an addition to the ever popular Aliner and Cruiseline range, the Adventure + series is stacked with features to enhance your adventure.

The upgraded 5" chassis, combined with the independent coil suspension and 15" wheels give you greater flexibility, while the air-conditioner, 80 watt solar panel, gas/electric hot water service and external shower ensure the comforts of home are not forgotten.

www.avan.com.au



Adventure Plus Upgrades

- > Upgraded 5" chassis
- > Independent coil suspension
- > Upgraded wall hinges
- > Upgraded draw runners
- > Upgraded cupboard hinges
- > Increased internal framing in wall structure
- > Air conditioner
- > 15" wheels with all terrain tyres
- > Entry grab handle
- > Radio CD player
- > External speakers
- > External shower with hot and cold water
- > Gas/electric hot water service
- > Alko off-road hitch
- > 80watt solar panel
- > External gas bayonet
- > External 12 volt and TV antenna point
- > 3 x external baggage doors
- > Inner spring mattress
- > Awning tracks
- > Microwave
- > DC charger
- > 12 Volt van battery and charger
- > 2 x large winding domes
- > 2 x 60 litre water tank

Aliner Layouts

Avan Aliner 2B - Lounge converts to double bed

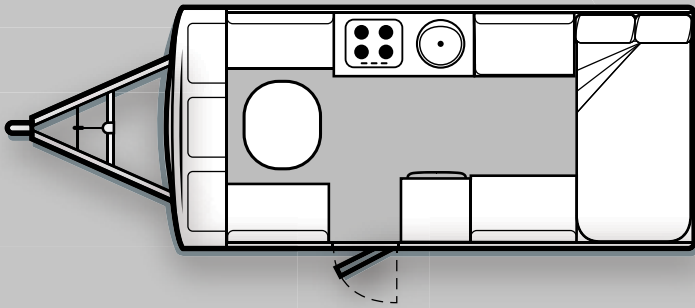

Avan Aliner 1 - Rear dinette converts to double bed

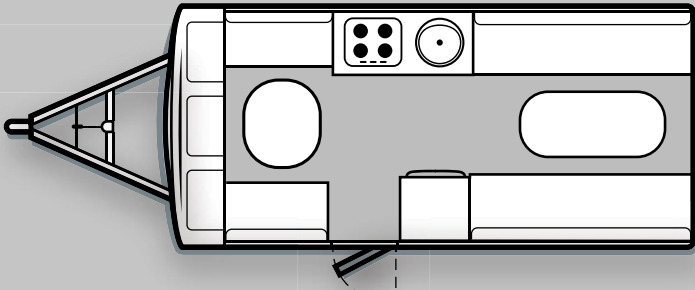

Avan Aliner 3C - Sofa converts to double bed

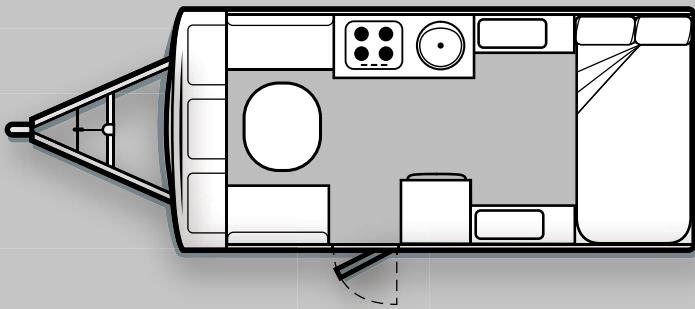

Avan Aliner 1D - Seats converts to single bed

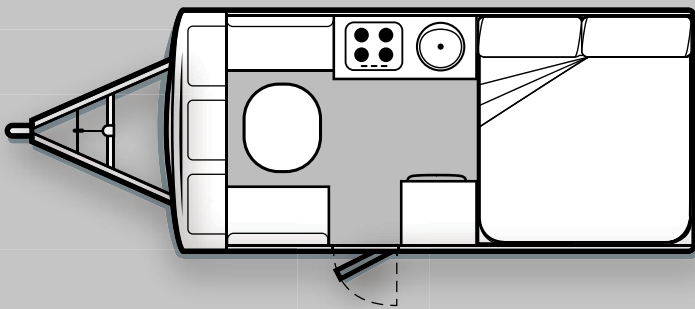

Avan Aliner 3 - Seats converts to double bed

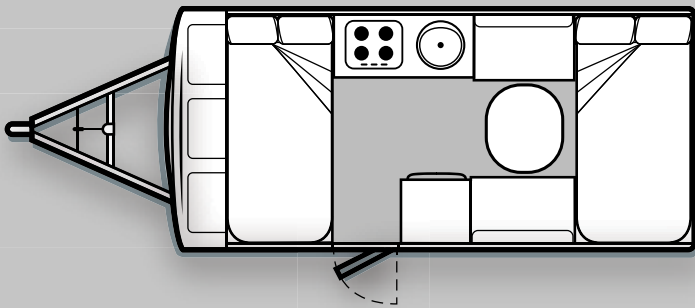

Avan Aliner 4 - Lounge converts to double bed

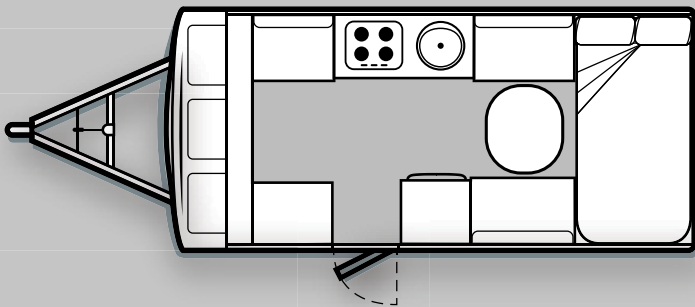

Aliner Specifications

External Body Length	3680mm
Interior Body Length	3380mm
Total Garage Length	4850mm
Travel Height	1650mm
Interior Height	2580mm
Width	2075mm
Approximate Ball Weight	65kg
Approximate Tare Weight	830kg

Sportliner Specifications

External Body Length	2680mm
Interior Body Length	2390mm
Total Garage Length	4000mm
Travel Height	1610mm
Interior Height	2160mm
Width	2075mm
Approximate Ball Weight	60kg
Approximate Tare Weight	710kg

Cruiser Specifications

External Body Length	3930mm
Interior Body Length	3615mm
Total Garage Length	5180mm
Travel Height	1720mm
Interior Height	2440mm
Width	2075mm
Approximate Ball Weight	70kg
Approximate Tare Weight	895kg

Cruiseline Specifications

External Body Length	4440mm
Interior Body Length	3615mm
Total Garage Length	5765mm
Travel Height	1720mm
Interior Height	2440mm
Width	2075mm
Approximate Ball Weight	100kg
Approximate Tare Weight	940kg

Allow approximately 30kg extra for adventure pack options

Sportliner Layouts

Avan Sportliner

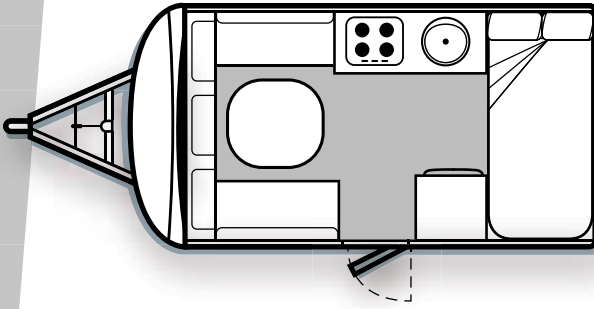

Avan Sportliner CL

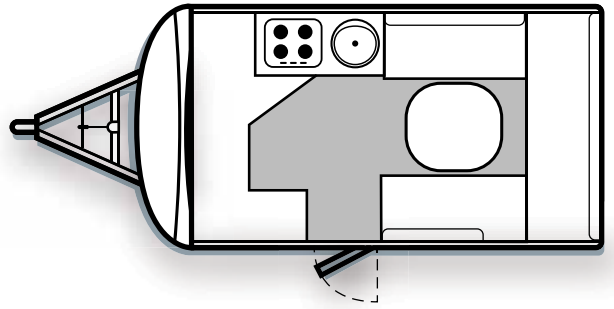

Avan Sportliner SB

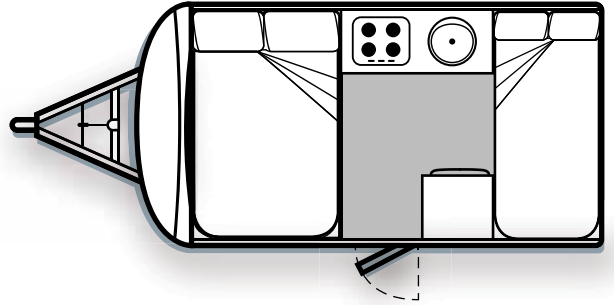

*Avan Cruiser & Cruiseline 1
Rear dinette converts to double bed*

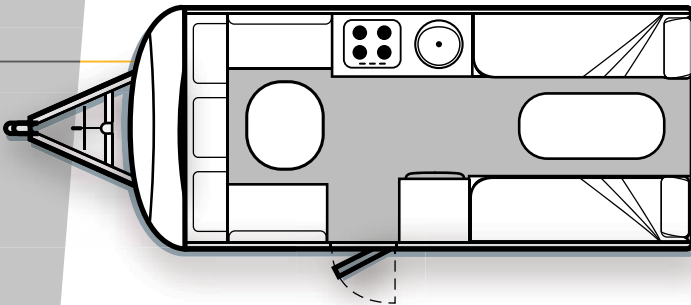

Cruiser & Cruiseline Layouts

Avan Cruiser & Cruiseline 1D - Seats converts to single bed

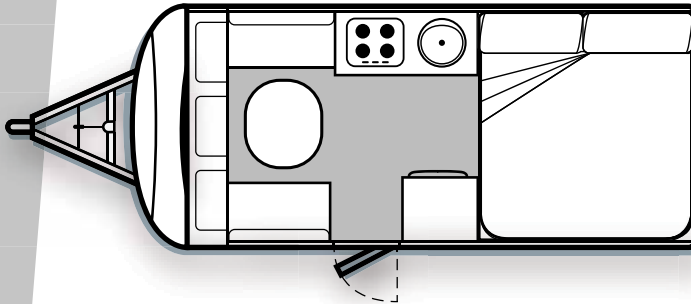

Avan Cruiser & Cruiseline 3C - Sofa converts to double bed

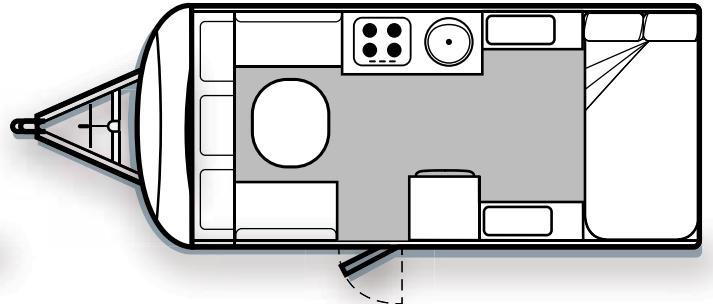

Avan Cruiser & Cruiseline 2B - Lounge converts to double bed

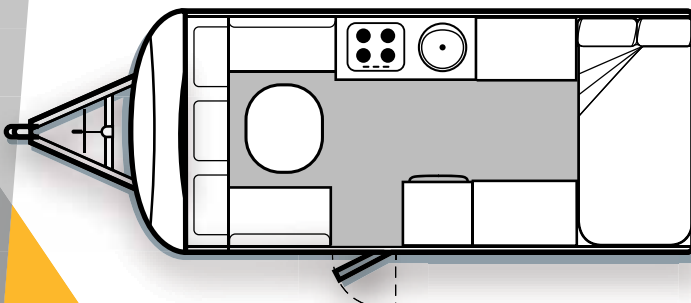

Avan Cruiser & Cruiseline 4A - Lounge converts to double bed

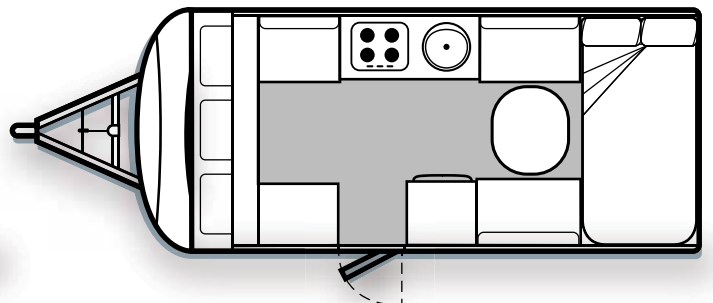

Avan Cruiser & Cruiseline 3 - Seats converts to double bed

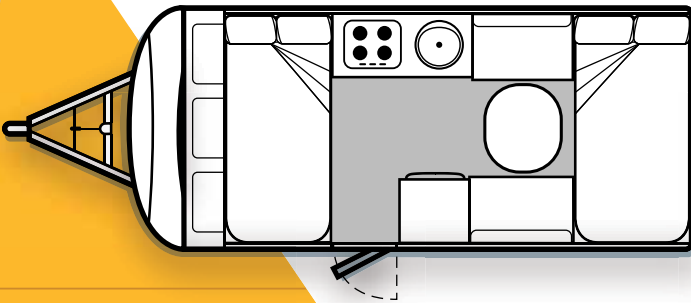

Avan Cruiser & Cruiseline 5 - Kitchen with single beds

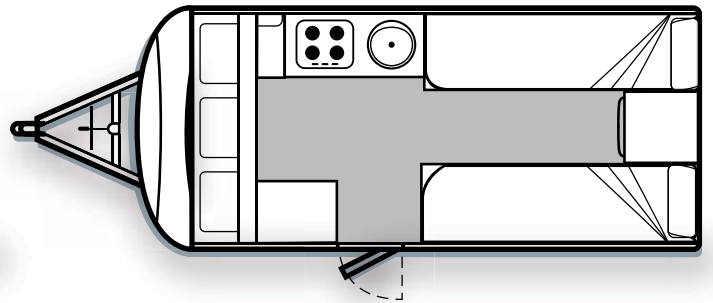



**ALINER, CRUISER, CRUISELINER,
SPORTLINER & PRODUCT CATALOGUE**

Avan... Others Follow.

Illustrations are not always standard units. Plans, dimensions and weights are subject to change without notice due to ongoing design and development of product and are subject to ©Copyright. All patents pending. Reproduction of materials may vary at time of manufacture. Please check with your Avan dealer to ensure your chosen van specifications, equipment and colours are available prior to placing order.





Avan Campers, Caravans, Motorhomes ©Copyright 2019



Authorised Dealer:



FOR MORE INFORMATION, PLEASE CONTACT

 **(07) 4151 3000**  SALES@SEARLESRVCENTRE.COM.AU  23 PHOEBE CRST,
 WWW.SEARLESRVCENTRE.COM.AU BUNDABERG QLD 4670